

the hallicrafters co.

SERVICE BULLETIN FOR MODEL S-40A

GENERAL

- Tubes Eight plus rectifier
- Speaker 5-inch PM
- Speaker V.C. Impedance. 3.2 ohms
- Headset Output Low Impedance
- Antenna Provision for external antenna
- Tuning Manual
- Tuning Range

Band Selector Position	Frequency Range
1.	540 kc - 1680 kc
2.	1680 kc - 5.4 mc
3.	5.3 mc - 15.5 mc
4.	15.5 mc - 44 mc
- Intermediate Frequency 455 kc.
- Power Supply Standard Model 105-125 V. 60 cycles AC
 Universal Model 105-250 V. 25/60 cycles AC
- Power Consumption 75 Watts

RESTRINGING DIAL CORD

To restring the general coverage tuning dial cord, cut an 18-inch length of 30 lb. test dial cord and tie one end to the tension spring of the main tuning capacitor drive pulley at position "1" on the diagram. Follow the numbers "1" through "4", and at position "4" stretch the tension spring and tie the cord securely.

To restring the band spread tuning dial cord, cut a 36-inch length of dial cord and follow the procedure as above, starting at position "A" on the diagram. Note that the tuning drive shafts are wrapped with three turns of dial cord for proper traction.

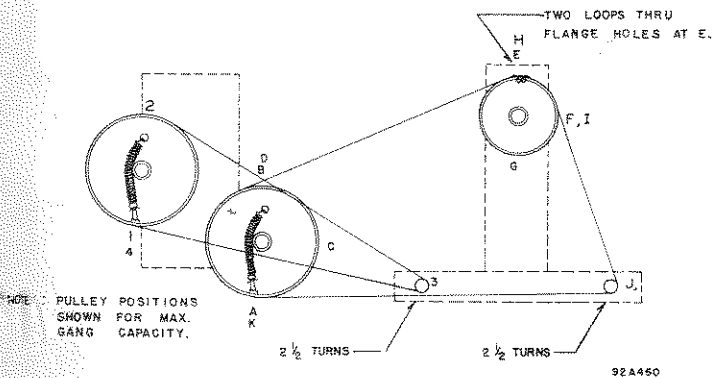
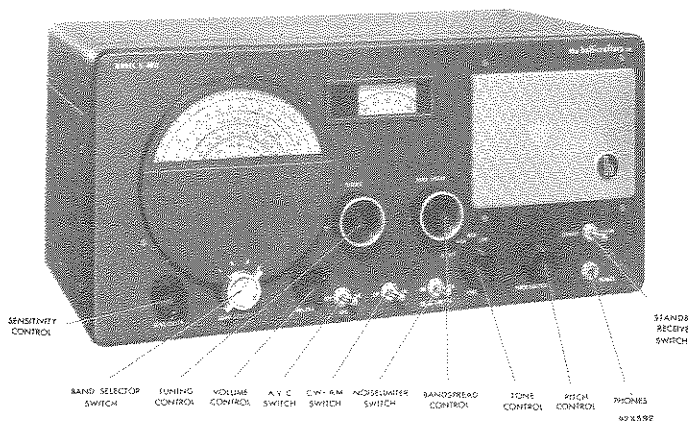

Fig. 1. Dial cable stringing procedure



REPLACING LAMPS

Refer to Fig. 4 for the location of the two dial lamps used in the receiver. To gain access to the defective lamps, lift the cabinet cover and unclip the dial lamp sockets. The sockets may then be brought out into the open to change the defective lamp. Replace defective lamps with 6-8 V. Mazda #44 (Blue bead) lamps or equivalent.

ALIGNMENT PROCEDURE

Set the following controls before alignment.

- SENSITIVITY Set at maximum
- VOLUME Set at maximum
- AVC switch. Set at OFF
- Band Spread Set at zero
- CW/AM Set at AM (See step 2)
- NOISE LIMITER Set at OFF
- STANDBY RECEIVE. Set at RECEIVE
- TONE SWITCH Set at HIGH

For the settings of the remaining controls, see alignment chart.

Access to the i-f amplifier alignment adjustments may be had through the cabinet top cover. R-F alignment should be done through the holes provided in the cabinet bottom because the oscillator calibration will be effected slightly by changes in the capacity between the cabinet bottom and the r-f coils and wiring.

Before starting the alignment procedure, check the position of the general coverage dial index marker on the low frequency end of the range and the bandspread dial zero position. The general coverage condenser should index at max. capacity, and the bandspread condenser at min. capacity.

The standard RMA dummy antenna mentioned in the alignment chart consists of a 200 mmf. condenser in series with a 20 uh r-f choke which is shunted by a 400 mmf condenser in series with a 400 ohm carbon resistor.

ALIGNMENT CHART

Step	Dummy Antenna	Signal Generator Coupling	Signal Generator Frequency	Band Switch Setting	Receiver Dial Setting	Adjust	Remarks
1	None	Stator plates in center section of tuning gang.	455 kc	"1"	1000 kc	1,2,3	Maximum audio output at speaker voice coil. Use just enough signal generator output to obtain a 50 mw signal level.
2	None	See step 1	455 kc (No modulation)	"1"	1000 kc	T-17	With the CW/AM switch set at CW, remove the pitch control knob and adjust T-17 for zero beat. Replace the knob with the dot in the center position.
3	Std RMA dummy	"A1" on antenna strip. Jumper connected between "A2" and "G"	36 mc	"4"	36 mc	*C-19, C-1, C-12	Maximum output as in step 1.
			18 mc			18 mc	
4	Std RMA dummy	See step 3	14 mc	"3"	14 mc	*C-20, C-2, C-13	Maximum output as in step 1.
			10 mc			10 mc	
5	Std RMA dummy	See step 3	5 mc	"2"	5 mc	*C-21, C-3, C-14	Maximum output as in step 1.
			1.8 mc			1.8 mc	
6	Std RMA dummy	See step 3	1500 kc	"1"	1500 kc	*C-22, C-4, C-15	Maximum output as in step 1.
			600 kc			600 kc	

*Note - Calibration adjustments.

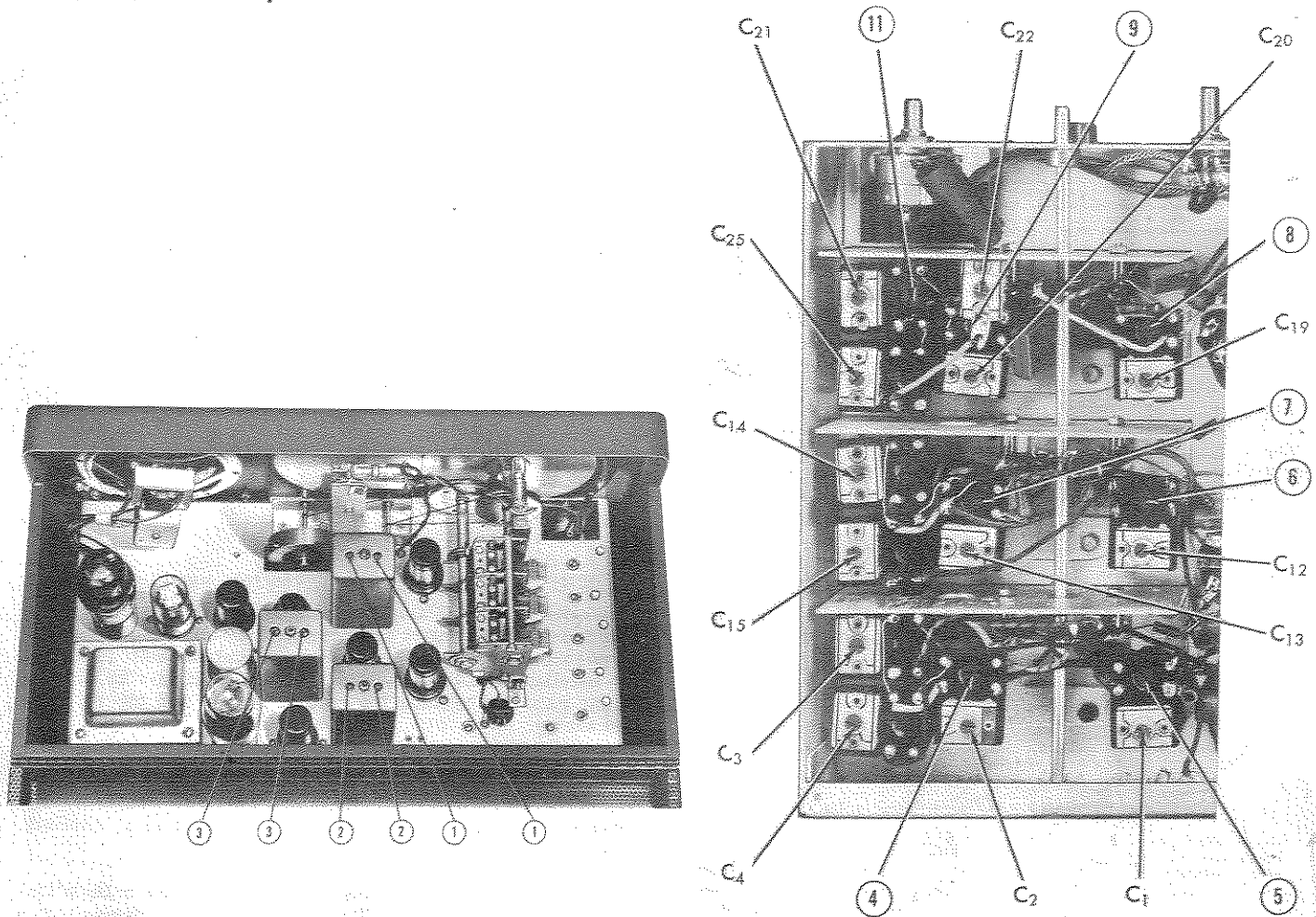
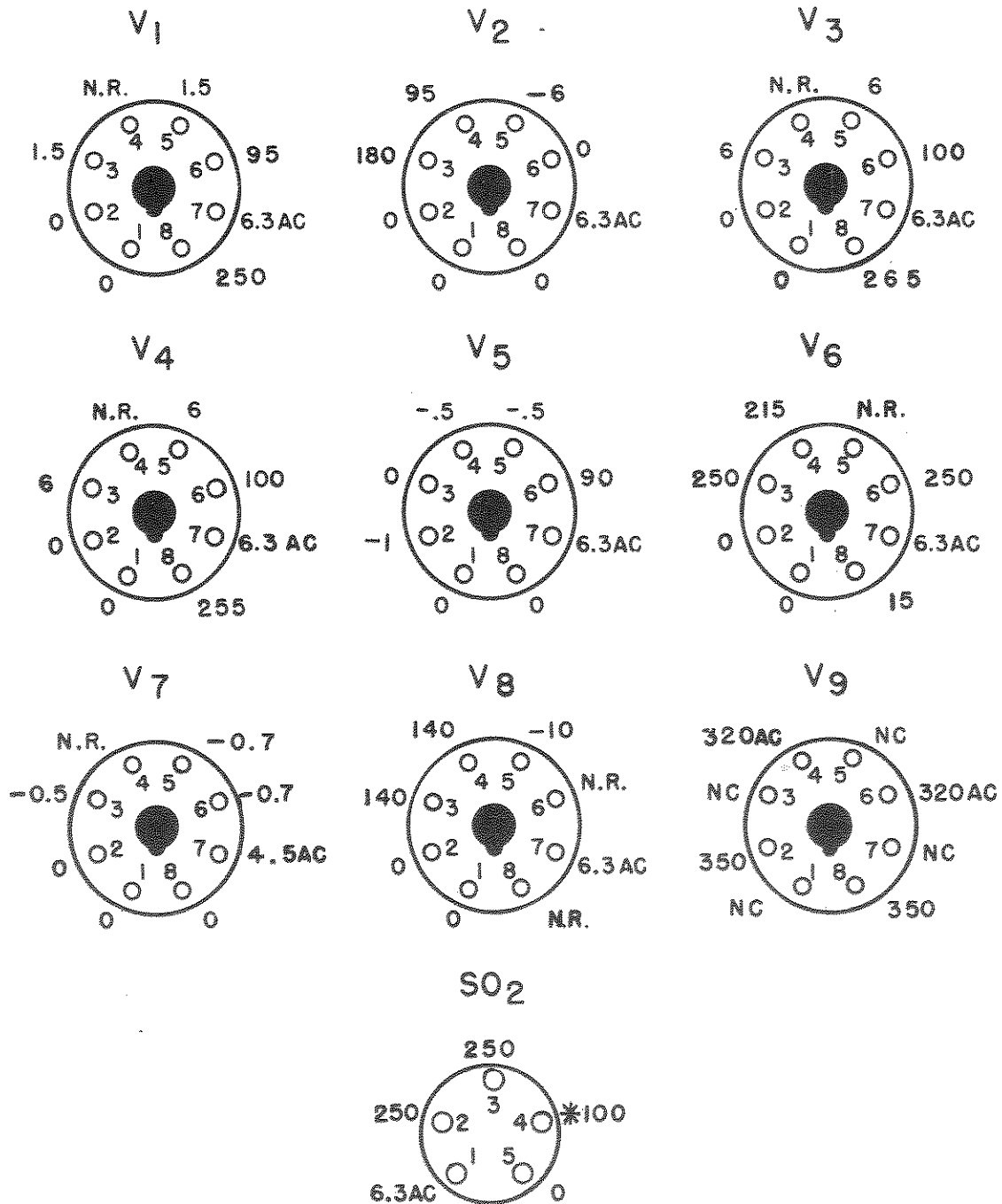

Fig. 2. Top and bottom view, alignment adjustment

TUBE SOCKET VOLTAGES (PIN VIEW)

ALL VOLTAGES ARE POSITIVE DC UNLESS OTHERWISE SPECIFIED



* "S" METER SWITCH CLOSED (MAX. CLOCKWISE);
 NR - NOT READABLE WITH METER USED.
 ALL READINGS TAKEN AT 117V. AC LINE VOLTAGE; WITH
 20,000 OHM/VOLT METER; NO SIGNAL BEING RECEIVED;
 CONTROLS SET AS FOLLOWS: STANDBY/RECEIVE SWITCH AT
 "RECEIVE"; AVC, NOISE LIMITER AT "ON"; AM/CW SWITCH
 AT "CW"; SENSITIVITY AND VOLUME CONTROLS FULL CLOCKWISE;
 TUNING, PITCH CONTROL AND TONE CONTROLS IN ANY
 POSITION AS THEY DO NOT AFFECT READINGS. BAND SELECTOR
 SET AT BAND I.
 NC - NO CONNECTION.

92B312

Fig. 5. Tube socket voltage chart

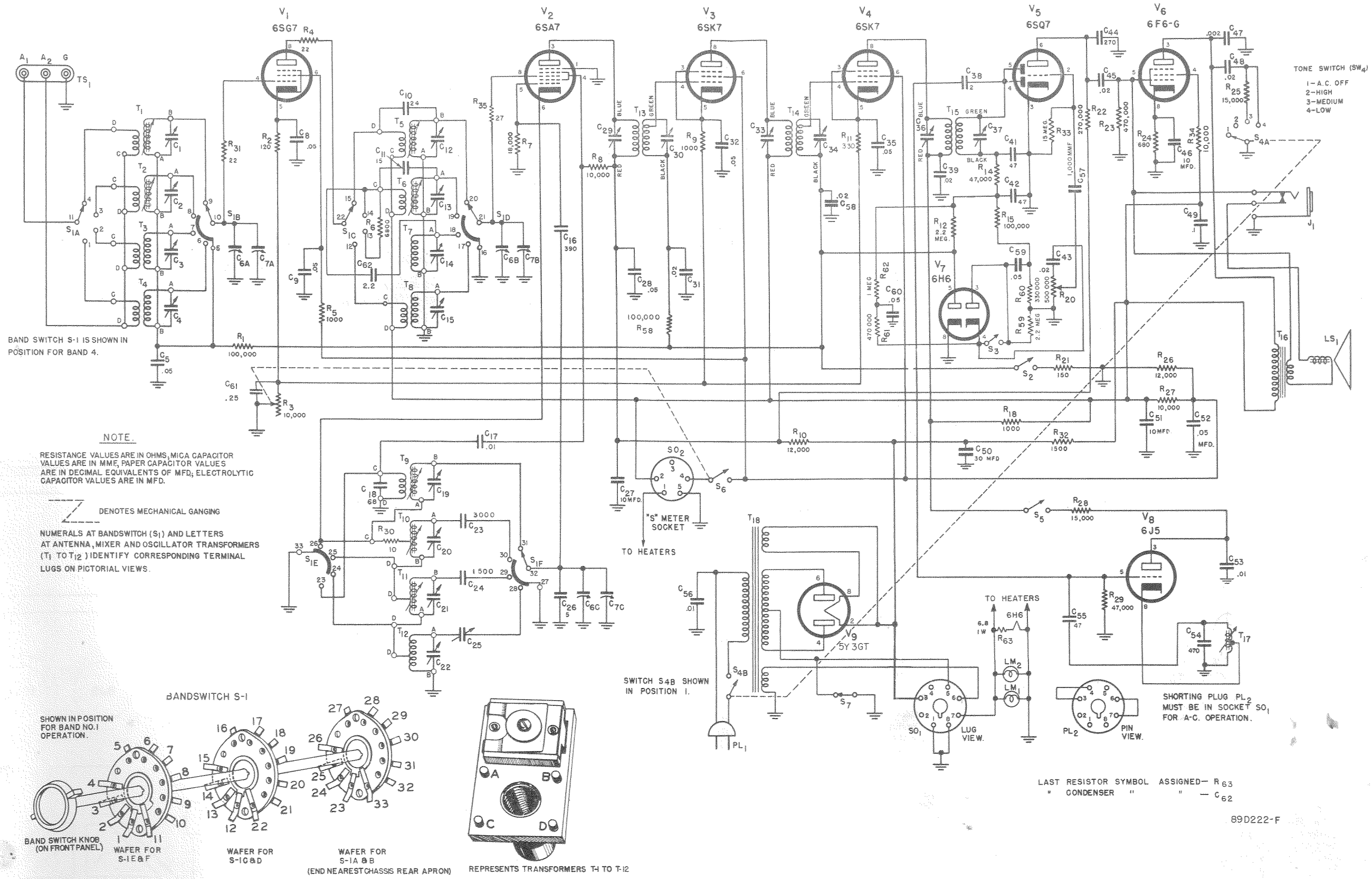
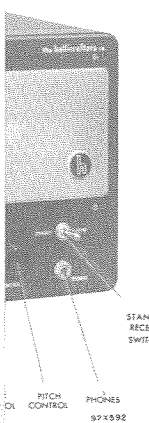

Fig. 6. Schematic diagram.



al lamps used in
 e lamps, lift the
 s. The sockets
 nge the defective
 Mazda #44 (Blue

imum
 imum
)
 (See step 2)
 RECEIVE
 H

alignment chart.
 tments may be
 ent should be
 bottom because
 tly by changes
 d the r-f coils

eck the position
 e low frequency
 position. The
 max. capacity,

ed in the align-
 n series with a
 nf condenser in

SERVICE PARTS LIST

Ref. No.	Description	Manufacturer's Part Number	Ref. No.	Description	Manufacturer's Part Number
CONDENSERS			TRANSFORMERS AND COILS (Cont.)		
C-1,2,12,13,19	Trimmer, adjustable, part of transformers T-1,2,5,6 and 9	44B149	T-12	Transformer, oscillator stage, band 1	51B912
C-3,4,14,15,20,21,25	Trimmer, adjustable, part of transformers T-3,4,7,8,10,11 and 12	44A147	T-13	Transformer, 1st IF	50C185
C-5	.05 mfd. 200 V., tubular	46A091	T-14	Transformer, 2nd IF	50C186
C-6,7	Tuning capacitor, 3 sections ganged	48C138	T-15	Transformer, detector stage	50C192
C-8,32,35,59,60	.05 mfd. 200 V., tubular	46AU503J	T-16	Transformer, audio output	55B093
C-9,28,52	.05 mfd. 400 V., tubular	46AW503J	T-17	Transformer, BFO	54B033-2
C-10	24 mmf. 500 V., ceramic	47X21UK240M	T-18	Transformer, power	52C140
C-11	15 mmf. 500 V., ceramic	47X21UK150M	*T-18	Transformer, power (universal)	52C139
C-16	390 mmf. 500 V., mica	47X20A391K	SWITCHES		
C-17,53	.01 mfd. 400 V., tubular	46AW103J	S-1	Bandswitch assy, ant. and mixer	62B039
C-18	68 mmf. 500 V., ceramic	47X25UK680K	S-2,3,5,7	Bandswitch ass'y, oscillator	62B044
C-22	Trimmer, adjustable	44A191		Switch, toggle, S.P.S.T., STANDBY-RECEIVE, A.V.C., A.N.L., and CW-AM	60A138
C-23	3,000 mmf. 500 V., mica	47X30C302K	S-4	Switch, PWR-TONE control	65A225
C-24	1500 mmf. 500 V., mica	47X30C152J	S-6	Switch, part of SENSITIVITY control R-3	
C-26	3 mmf. temperature compensator for osc. stage	44A158	PLUGS AND SOCKETS		
C-27,50,51	30-10-10 mfd. 450 V., electrolytic	45A064	J-1	Jack, headset	36A002
C-31,43,58	.02 mfd. 200 V., tubular	46AU203J	PL-1	Line cord	87B1573
C-38	2 mmf., twisted wire gimmick		PL-2	AC shorting plug	87B1573
C-39,45,48	.02 mfd. 600 V., tubular	46AU203J	SO-1	Socket, POWER (DC operation)	6A035
C-41,42,55	47 mmf. 500 V., mica	47X20A470M	SO-2	Socket, "S" meter connection (5 prong)	6A186
C-44	270 mmf. 500 V., mica	47X20A271K		Socket, octal (tube)	6A035
C-46	10 mfd. 25 V., electrolytic	45A121		Socket, dial light, general coverage dial	86B070
C-47	.002 mfd. 1000 V., tubular	46A104		Socket, dial light, bandspread dial	86B049
C-49	.1 mfd. 400 V., tubular	46AV104J	TUBES, RECTIFIERS AND LAMPS		
C-54	470 mmf. 500 V., mica	47X20A471J	V-1	Type 6SG7, antenna	90X6SG7
C-56	.01 mfd. 600 V., molded paper	46AC103J	V-2	Type 8SA7, mixer	90X6SA7
C-57	1000 mmf. 500 V., mica	47X25A102M	V-3,4	Type 6SK7, 1st and 2nd i-f amplifiers	90X6SK7
C-61	.25 mfd. 200 V., tubular	47A160-4	V-5	Type 6SQ7, detector, audio amplifier	90X6SQ7
C-62	2.2 mmf. 500 V., bakelite	46AT254J	V-6	Type 6F6G, audio power amplifier	90X6F6G
RESISTORS			V-7	Type 6H6, gas gate and noise limiter	90X6H6
R-1,15,58	100,000 ohms 1/2 watt, carbon	23X20X104M	V-8	Type 6J5, BFO	90X6J5
R-2	120 ohms 1/2 watt, carbon	23X20X121K	V-9	Type 5Y3GT, rectifier	90X5Y3GT
R-3	10,000 ohms, SENSITIVITY Control	25A533	LM-1,2	Lamp, dial light, Mazda #44	39A003
R-5,18	1000 ohms 1/2 watt, carbon	23X20X102K	MISCELLANEOUS		
R-6	6800 ohms 1 watt, carbon	23X30X682K	TS-1	Terminal strip, antenna	88A032
R-7	18,000 ohms 1/2 watt, carbon	23X20X183K		Lock, line cord	76A299
R-8	10,000 ohms 2 watts, carbon	23X40X103K		Shaft, bandswitch and index plate	74B172
R-9	1000 ohms 1/2 watt, carbon	23X20X102M		Collar, bandswitch	77A043
R-10	12,000 ohms 4 watts, carbon	23X65C123K		Bracket, dial drive mtg.	67B503
R-11	330 ohms 1/2 watt, carbon	23X20X331K		Dial shaft, bandspread	74A169
R-12,59	2.2 megohms 1/2 watt, carbon	23X20X225M		Drive shaft, main tuning	74A171
R-14,29	47,000 ohms 1/2 watt, carbon	23X20X473M		Drive shaft, bandspread	74A170
R-20	1/2 megohm, VOLUME control	25A534		Washer, spring (Bandswitch, bandspread dial, and main tuning drive shafts)	4A043
R-21	150 ohms 1/2 watt, carbon	23X20X151M		Spring, retainer (Bandspread, and main tuning drive shaft)	75A062
R-22	270,000 ohms 1/2 watt, carbon	23X20X274K		Flywheel, bandspread tuning	71A178
R-23,61	470,000 ohms 1/2 watt, carbon	23X20X474M		Pulley, bandspread dial	28A012
R-24	680 ohms 1 watt, carbon	23X30X681K		Dial cord	38A001
R-25	15,000 ohms 1 watt, carbon	23X30X153M		Spring, dial cord	75A012
R-26	12,000 ohms 2 watts, carbon	23X40X123K		Dial, bandspread	83B254
R-27	10,000 ohms 4 watts, carbon	23X65CE103K		Dial, general coverage	83D240
R-28	15,000 ohms 2 watts, carbon	23X40X153M		Escutcheon, bandspread dial	7B017
R-30	10 ohms 1/2 watt, carbon	23X10X100M		Escutcheon, general coverage dial	7C034
R-31	22 ohms 1/2 watt, carbon	23X20X220M		Speaker, P.M. (5-inch)	85B050
R-32	1500 ohms 10 watts, WW	24BG152E		Baffle, speaker	63C223
R-33	15 megohms 1/4 watt, carbon	23X10X156M		Grill, speaker	7C016
R-34	10,000 ohms 1/2 watt, carbon	23X20X103M		Knob, PITCH CONTROL	15A058
R-35	27 ohms 1/2 watt, carbon	23X20X270K		Knob, SENSITIVITY, VOLUME and TONE	15A049
R-60	330,000 ohms 1/2 watt, carbon	23X20X334K		Knob, TUNING and BANDSPREAD	15A047
R-62	1 megohm 1/2 watt, carbon	23X20X105M		Knob, BAND SELECTOR	15B053
R-63	6.8 ohms 1 watt, carbon	23X30X068K			
TRANSFORMERS AND COILS					
T-1	Transformer, antenna stage, band 4	51B783			
T-2	Transformer, antenna stage, band 3	51B782			
T-3	Transformer, antenna stage, band 2	51B781			
T-4	Transformer, antenna stage, band 1	51B780			
T-5	Transformer, mixer stage, band 4	51B787			
T-6	Transformer, mixer stage, band 3	51B786			
T-7	Transformer, mixer stage, band 2	51B785			
T-8	Transformer, mixer stage, band 1	51B784			
T-9	Transformer, oscillator stage, band 4	51B791			
T-10	Transformer, oscillator stage, band 3	51B913			
T-11	Transformer, oscillator stage, band 2	51B789			

* Used on universal model S-40AU only.

Manufacturer's number

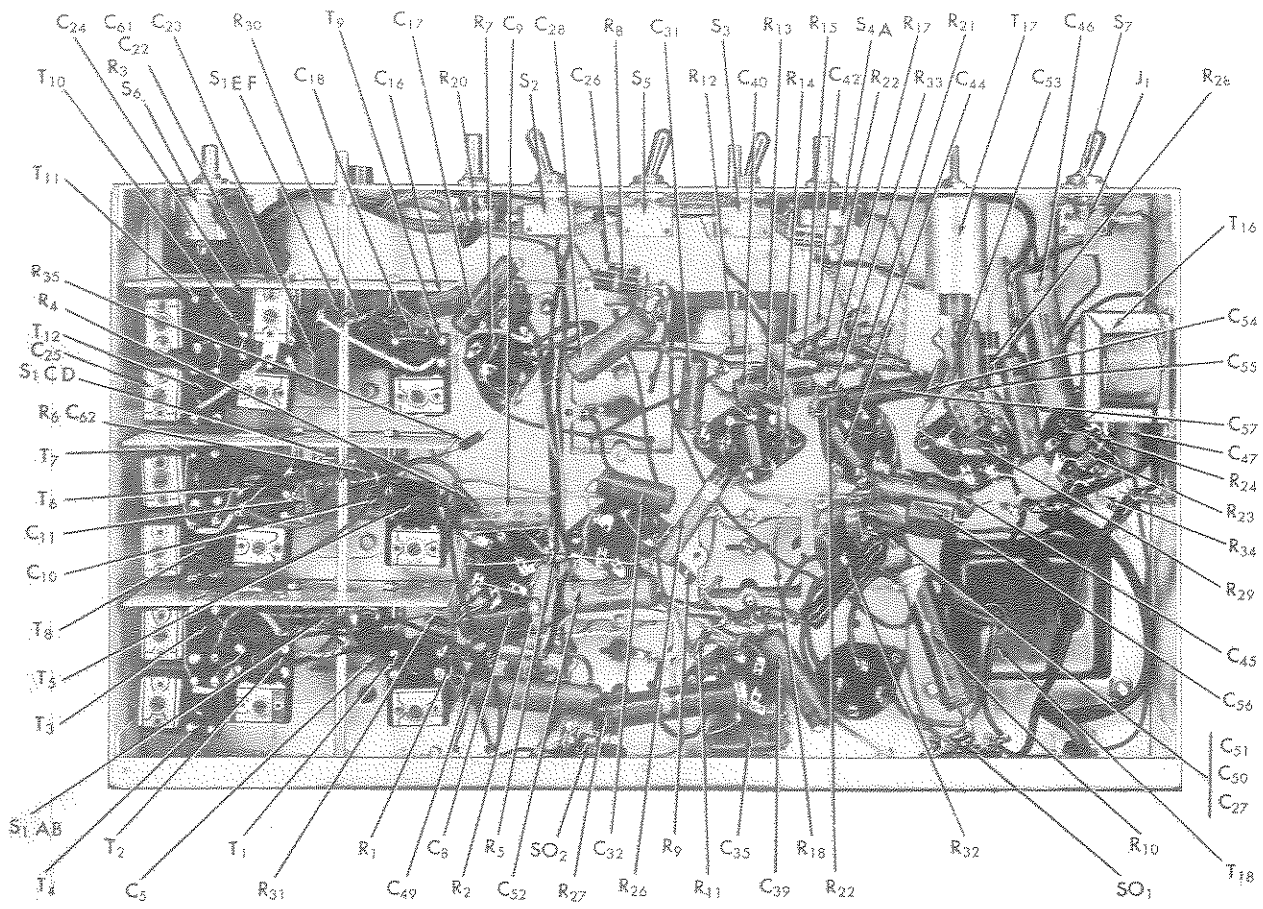

Fig. 3. Bottom view, component location

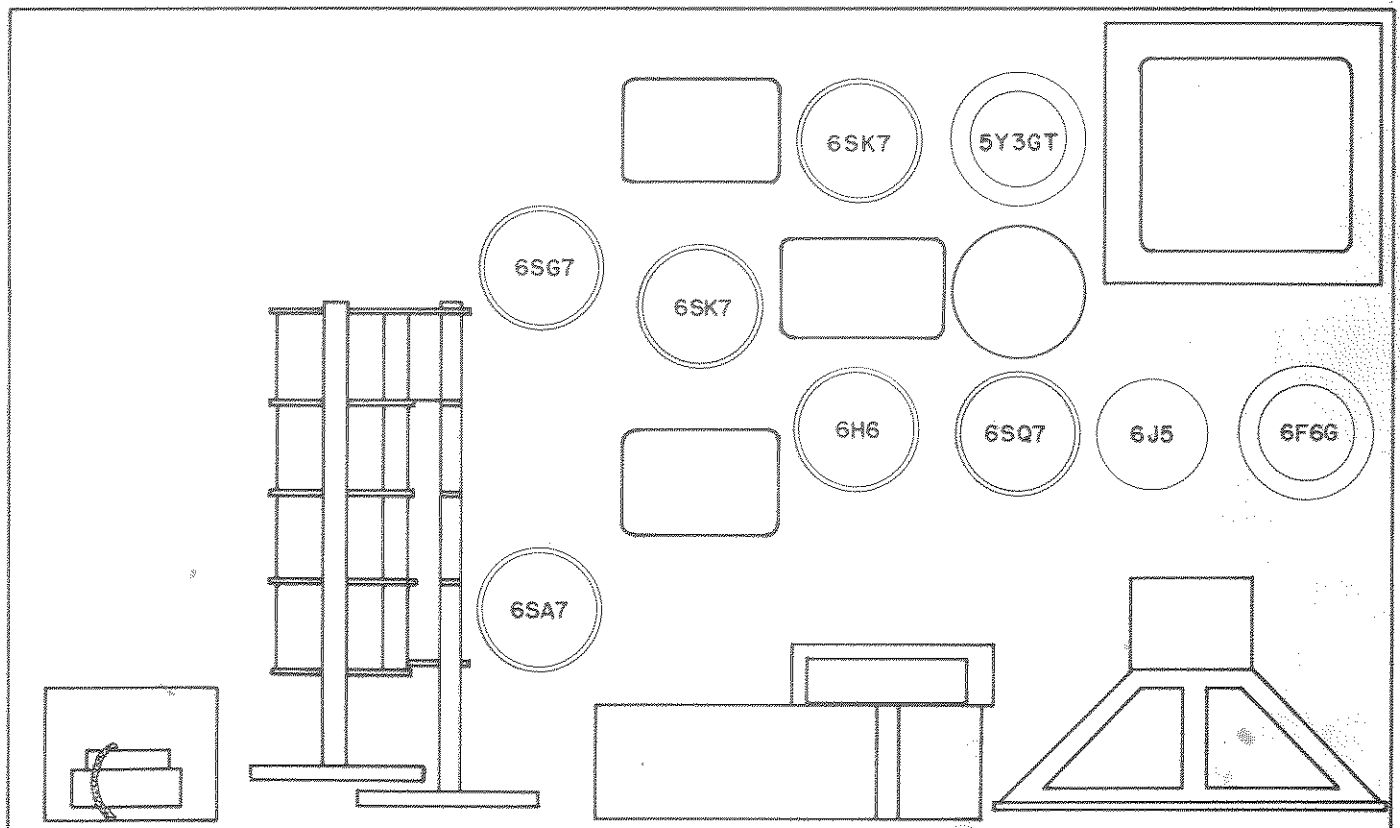

Fig. 4. Top view, tube location